

ASSEMBLY INSTRUCTION









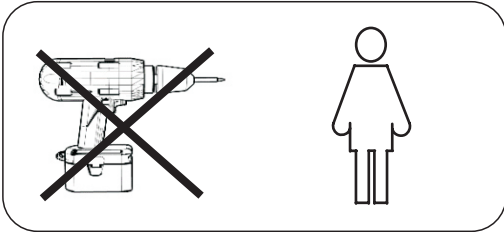

PAISLEY CHAIR

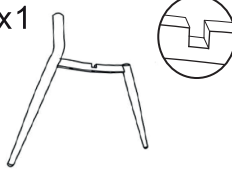

ROWICO

HOME



Ax1 	Fx4  M6x55mm
Bx1 	Gx4  M6x40mm
Cx1 	Hx1 
Dx1 	Ix1 
Ex1  M6x40mm	Jx4 

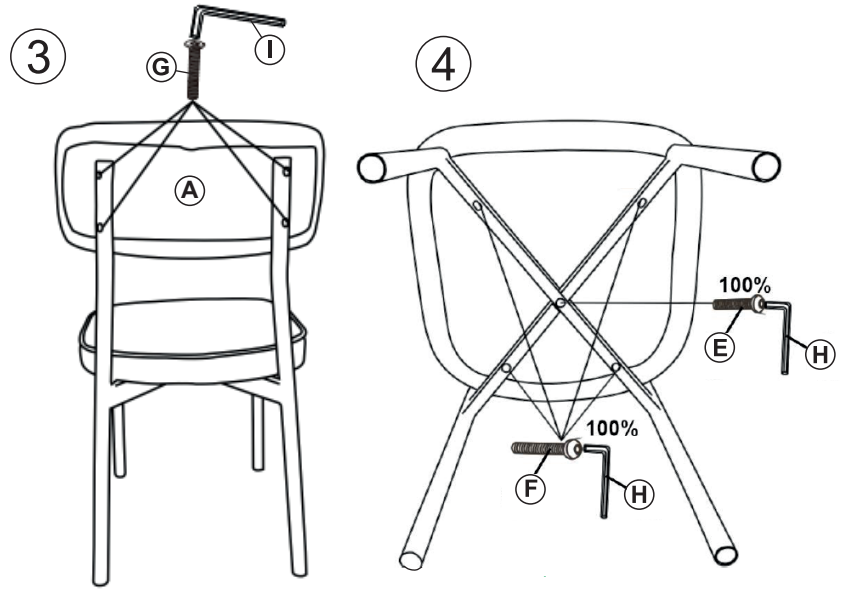
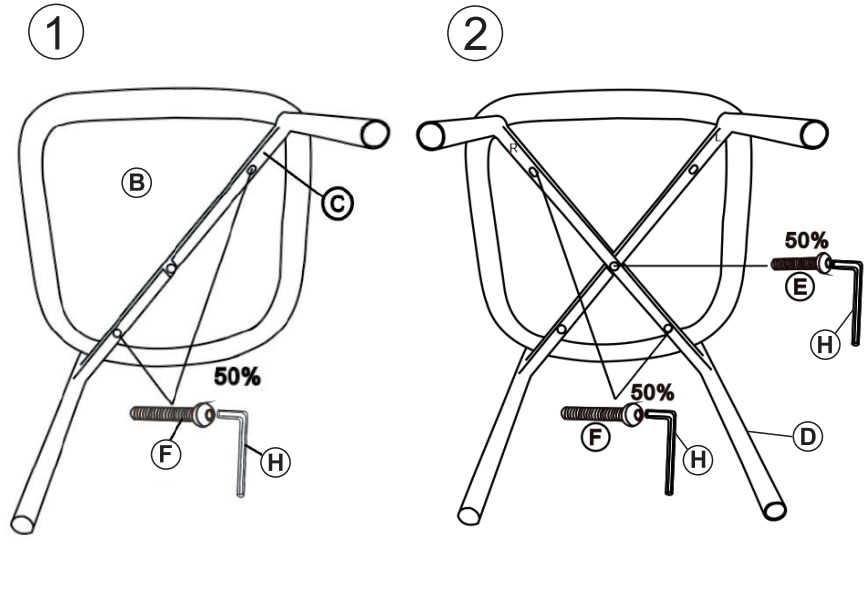

OBS!

Tänk på att det är viktigt att samtliga skruvar på stolen efterspänns regelbundet, beroende på användargrad och inomhusklimat.

Attention!

It might be necessary to re-tighten all screws on the chair on a regular basis, depending on the level of use and the room climate.

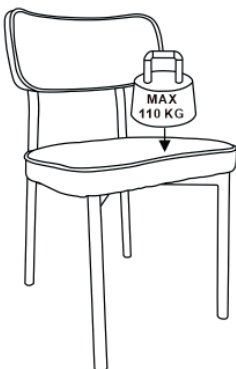

5

