

ASSEMBLY INSTRUCTION

OVAL COFFEE TABLE 80x40

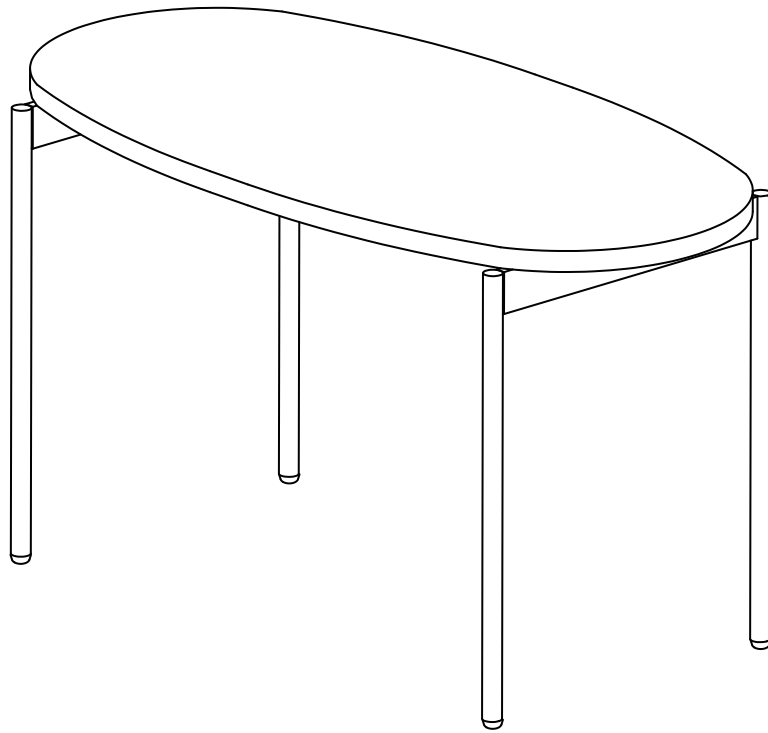

ROWICO

HOME

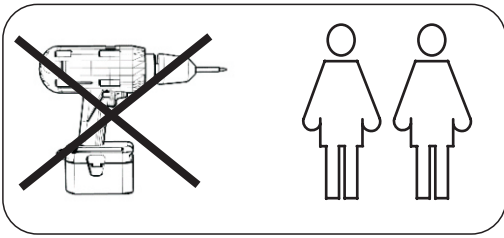

<p>Ax2</p>	<p>Dx1</p> <p>N4</p>
<p>Bx2</p>	<p>Ex8</p> <p>M6 × 12</p>
<p>Cx1</p>	<p>Fx8</p> <p>Ø16/Ø8</p> <p>Gx8</p>

1

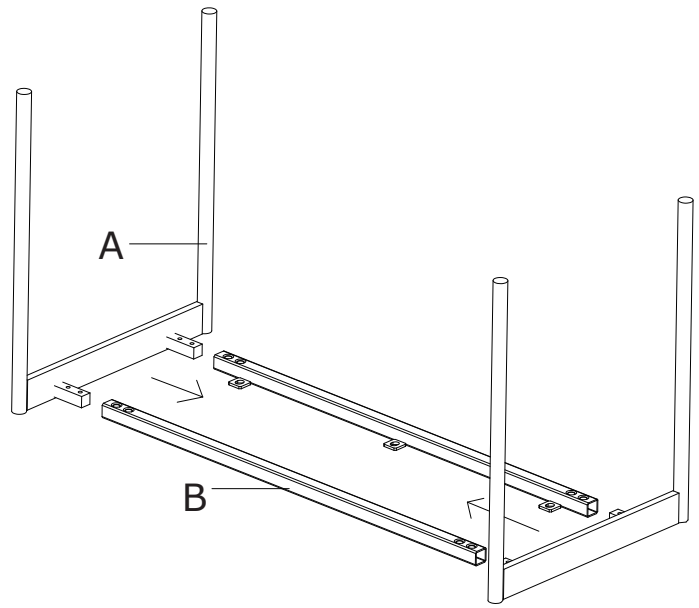

2

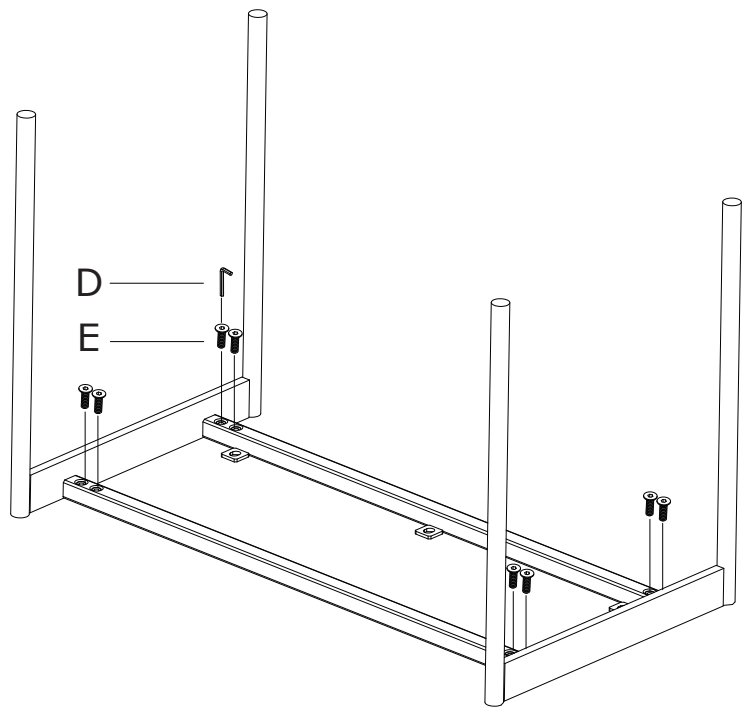

- ③ Montera bordstoppen med de skruvar som ligger i bordstoppens förpackning. Spänn inte för hårt.

Assemble the supplied screws/washer into the pre-drilled holes. Do not tighten too much.

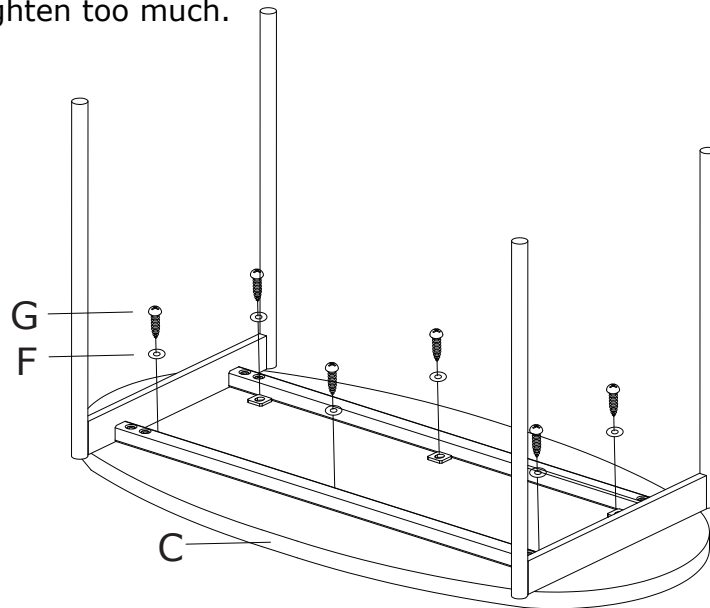

- ④ Justera med hjälp av de justerbara fötterna så att bordet står plant.

Adjust the table so it is plane with the adjustable feet.

